

Analysing water online compact and low maintenance

/ Everything at a glance / Process monitoring plays a crucial role in water treatment. Be it waterworks, pharmaceutical companies, food or beverage producers: Applicable regulations to ensure high water quality must always be observed. Many plant operators therefore monitor their treatment process continuously. Bürkert's Online Analysis System makes this task very easy and ensures you have a clear overview of your water and your performance figures at all times.

Water quality varies greatly not only worldwide but also regionally. As a result, water treatment requirements also differ. In order to guarantee an optimum end product, you must constantly monitor the quality of the water, even during the individual treatment steps. This applies in particular if you supply water to end consumers or processing companies.

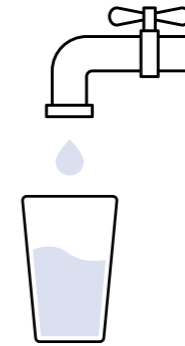

Read on the following pages how you can keep an eye on your water quality and the respective measuring parameters at all times.

/ Quality is the key / Whether you produce drinking water, beer or medicines: The quality of the water in your production processes must be right. If it decreases, the time and effort required for treatment and instrumentation increases – when working with a conventional measurement solution.

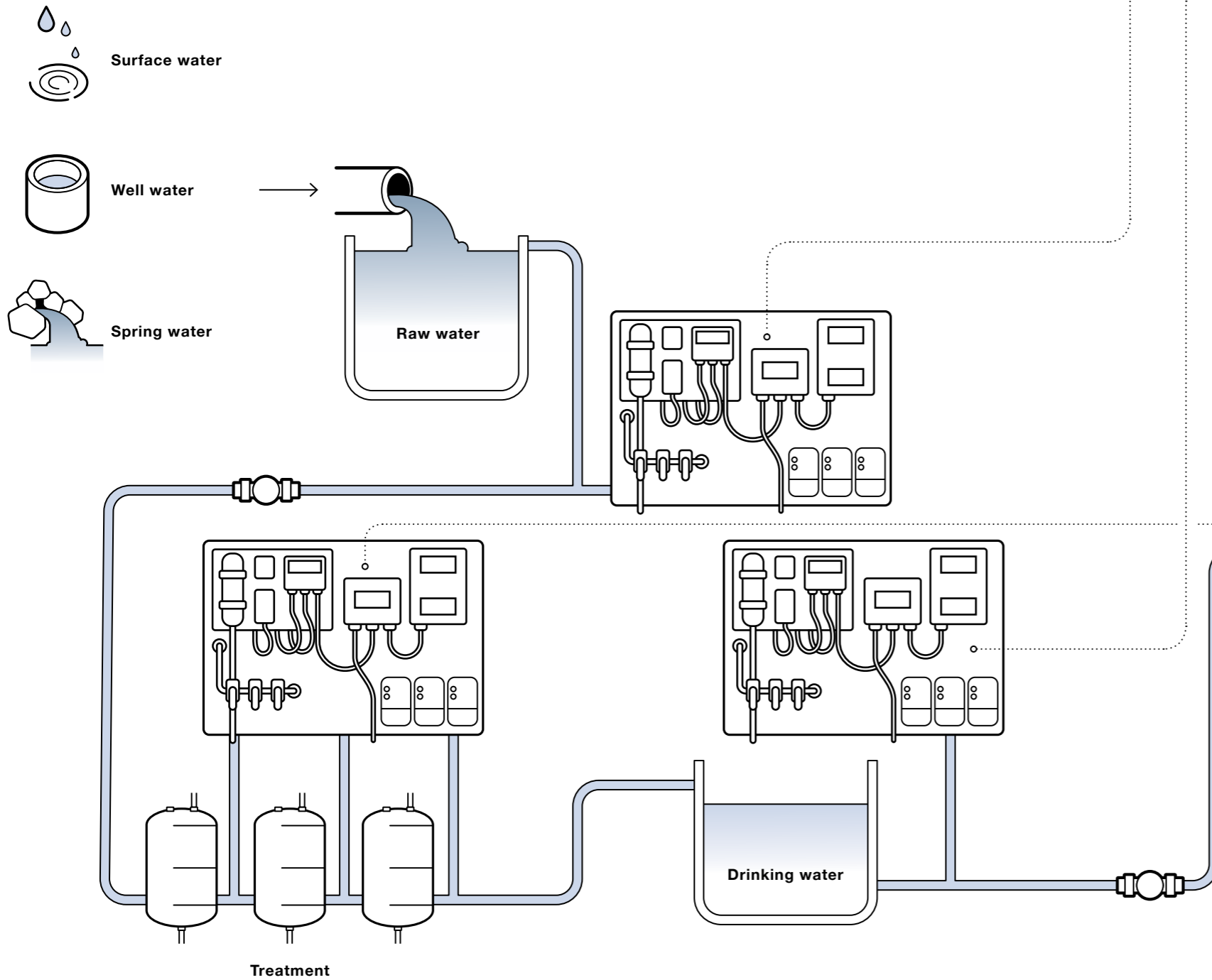

Conventional solution

Large measuring walls demand a lot of space in your plant. The time and effort required for manual analysis procedures is high. In addition, there are time-consuming external laboratory analyses.

Each analysis sample results in a high consumption of water.

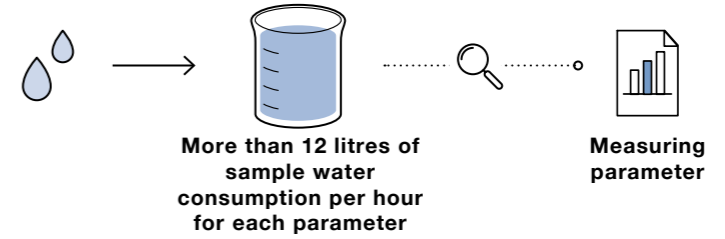

You need a separate device for each measuring parameter, making it expensive, maintenance-intensive and inefficient.

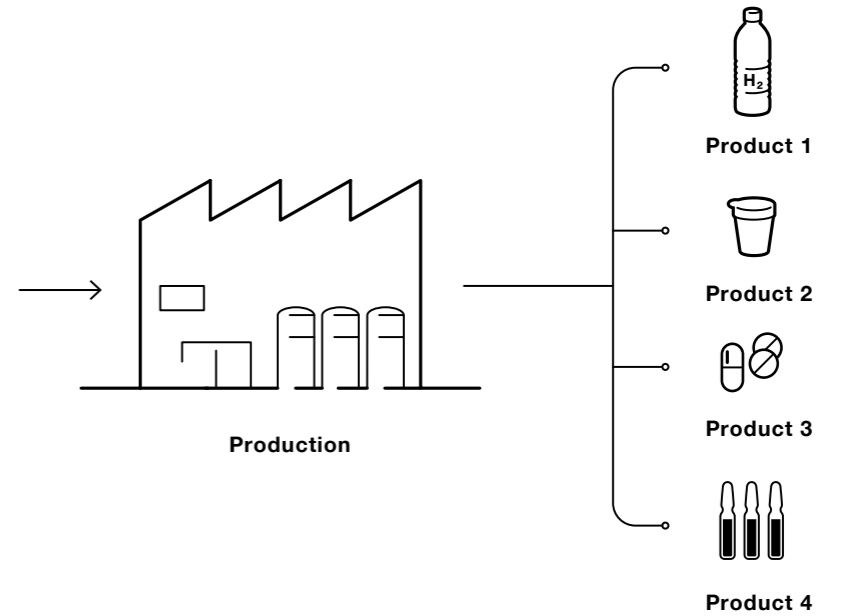

/ Monitoring and analysing water online / Bürkert's Online Analysis System Type 8905 provides you with a space-saving and safe solution. It allows you to monitor all key water parameters with just one system – continuously, precisely and with low maintenance.



Online Analysis System
Type 8905

Compact system

Up to six different water parameters can be measured with just one device. Distributed across your entire process, you can connect up to 30 sensors to one device.

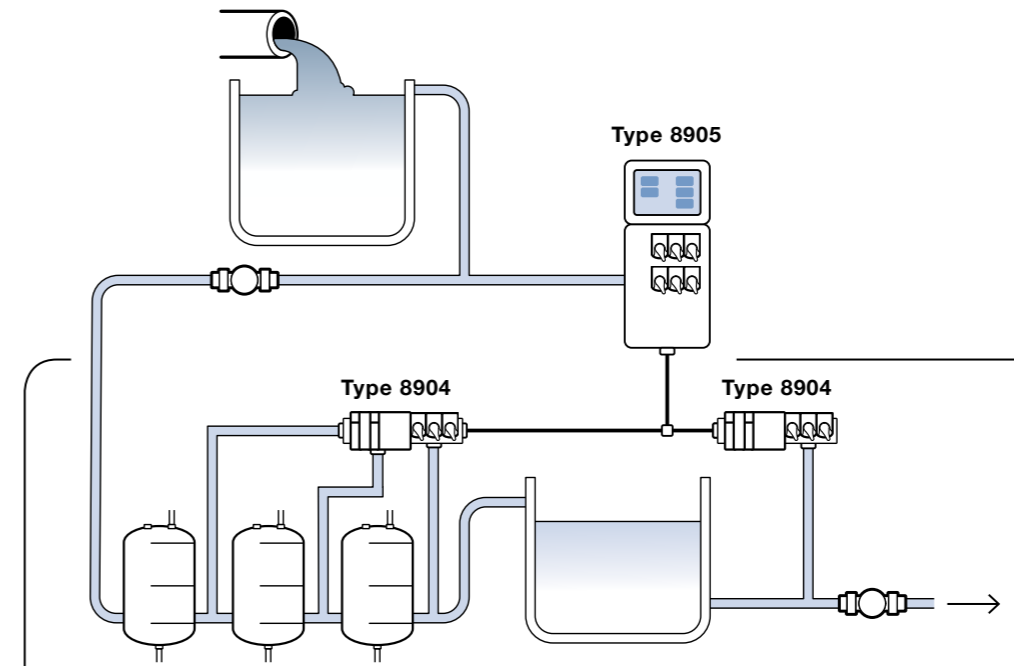

Maintenance



Thanks to the technologies applied in the individual sensor cubes, there is significantly more time between maintenance intervals. Less maintenance means more time saved.

Continuous monitoring



Thanks to the PLC connection, you always have an overview of all the measurement data whenever and wherever you need it.

Keeping water quality under control



Manual sampling is so yesterday: Today, simply program the measuring solution according to your needs and receive measured values continuously.

Minimum workload



Automatic measuring reduces your workload enormously. A high-resolution 7" touchscreen ensures intuitive operation and clear visualisation.

Hot-Swap technology



Simply remove sensor cubes for maintenance, even during operation. This reduces downtime.

Documentation



Due to continuous control and data storage, you can rely on secure and easy-to-document process flows.

Easy water quality measurement



Type 8905 covers all key parameters in just one system: Chlorine, chlorine dioxide, pH, ORP, conductivity, turbidity and iron.

Sustainable processes



The Online Analysis System is environmentally friendly and sustainable in operation thanks to its low water consumption.

/ The right sensor cube for every requirement / Miniaturisation of the sensor elements is the central innovation of the Online Analysis System. The ultra-compact sensor cubes can be easily inserted into the system.

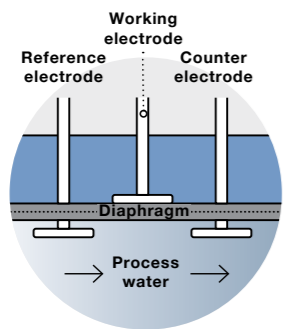

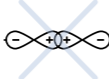

No electrolyte necessary

< 6 litres of water for every measuring procedure

Chlorine and chlorine dioxide measurement

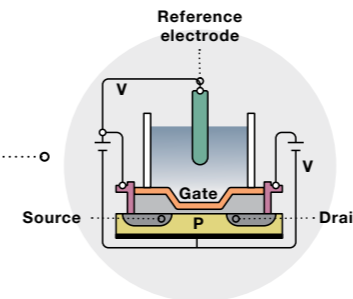
Chlorine is used against harmful microorganisms and to disinfect drinking water. Unlike conventional solutions, the sensor cube measures without electrolytes, which makes the sensor particularly low maintenance. Additionally, it carries out measurements in a very stable manner, irrespective of the pressure and flow rate. The maintenance effort is low and you only need to replace the measuring cell every 2-3 years.



System modularity

Reduction of maintenance and calibration

pH measurement

The pH value is an indicator of the balance in drinking water. This measurement reduces maintenance and calibration effort thanks to ISFET (ion sensitive field effect transistor) technology. It enables stable long-term measurement, especially for drinking water applications.





Fully automated analysis

Low reagent consumption

Iron measurement

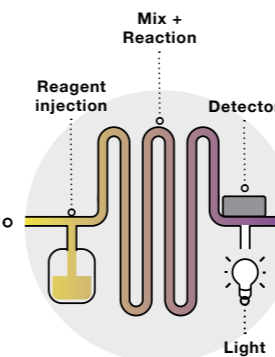
Iron is measured to remove highly reactive oxidising ingredients. The advantage here is the fully automated, miniaturised measuring method. The flow injection analysis measures iron intermittently. Reagent recognition using barcodes eliminates confusion. The low reagent consumption makes the method so economical.



/ Additional added value / Thanks to hot-swap functionality, all sensor cubes can be removed and reinstalled during operation without extra configuration. This is necessary in order to clean the sensor cubes, thereby guaranteeing precisely measured values at all times.





 **Easy to operate**

 **Long operating duration**

ORP measurement

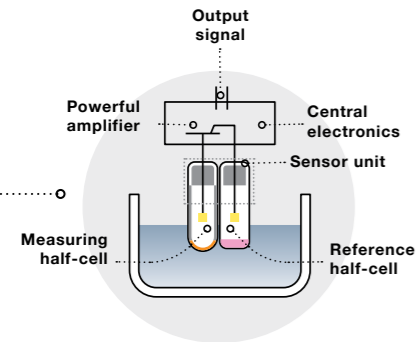
The ORP value or "Redox" measures sum parameters for the oxidising or reducing potential of water. Carrying out the ORP measurement with a sensor cube offers a number of advantages: Operation and maintenance are very simple, the sample water flow rate is minimal and the operating duration long.



 **Simple water preparation**

 **DIN/ISO 7027 or EPA method 180.1**

Turbidity measurement

Turbidity is the indicator for ingredients and suspended matter not dissolved in water. The sensor cube measures the level of turbidity in accordance with applicable standards and directives. The time and effort required for water preparation is small with cuvette measurements. Since only a small amount of sample water is required, the measurement reacts quickly to changes in the sample water.

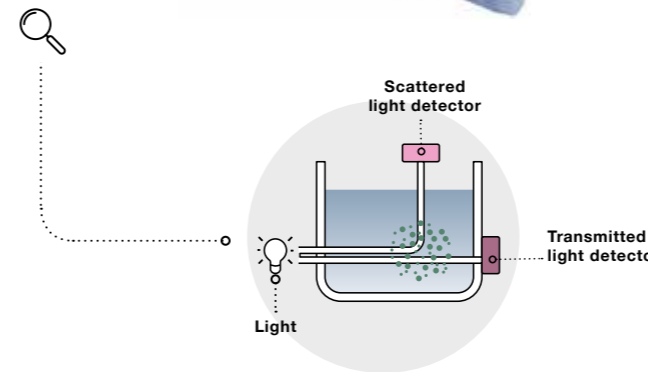

 **Easy to operate**

 **Maintenance free**

Conductivity measurement

Conductivity is the indicator for ingredients and minerals dissolved in water. Their maintenance-free measurement via the modular sensor cube is particularly suitable for drinking water. It is easy to operate, has a resistive 2-electrode sensor, hot-swap and a minimal sample water flow rate.

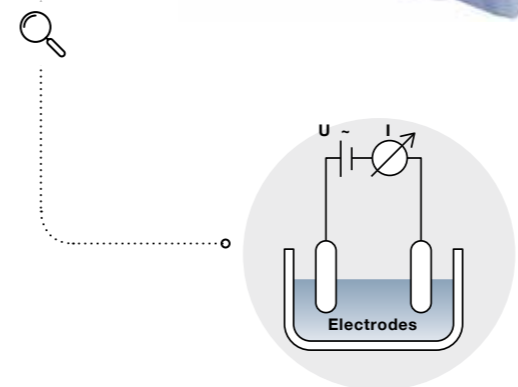

/ Variants for your application / Would you like to use the Online Analysis System in an easy-to-clean control cabinet or as a distributed field unit? We offer you flexible variants adapted to your requirements and your environment.



Control cabinet solution

All your measured values are always at hand in the control cabinet solution Type 8906. The robust control cabinets protect the components against external influences, can be supplied with a lock upon request and offer a degree of protection up to IP65.

- / Individual and application-related sensor technology
- / Automatic cleaning units
- / Compact control cabinet



Field units

The individual field units Type 8904 are installed in a distributed manner at each point in the process to meet your application needs.

- / Distributed installation
- / Parameters can be read from a central point
- / Digital communication between devices



/ Accessories / For cleaning or calibrating tasks as well as for ideal sample water treatment, Bürkert offers useful accessories that suit your Online Analysis System. In addition, we offer a bubble trap and a pressure reducer for treating the sample water.



Cleaning and calibrating unit

If the water quality results in deposits or the water contains an excessive amount of lime, regular cleaning is necessary. The fully automated cleaning unit quickly pays for itself. Cleaning is completed automatically and individually time-controlled. You can adjust the cleaning liquid according to the level of contamination. To achieve error-free measurement results, we recommend using the cleaning unit parallel to the turbidity sensor.



Fully automatic cleaning unit

If the water quality is poor or the water contains an excessive amount of lime, regular cleaning is necessary. The fully automated cleaning unit quickly pays for itself. Cleaning is completed automatically and individually time-controlled. You can adjust the cleaning liquid according to the level of contamination. To achieve error-free measurement results, we recommend using the cleaning unit parallel to the turbidity sensor.



/ Intelligent communication / Do you want to network various devices and exchange and utilise process or maintenance information? A standard communication interface makes this possible. With the Online Analysis System Type 8905, this networking functions down to the sensor and actuator level. This allows you to control your entire process easily and efficiently using device and intuitive user interfaces. The system is easy to start up and parameterise. Its modular design allows it to be constantly expanded while still saving space.

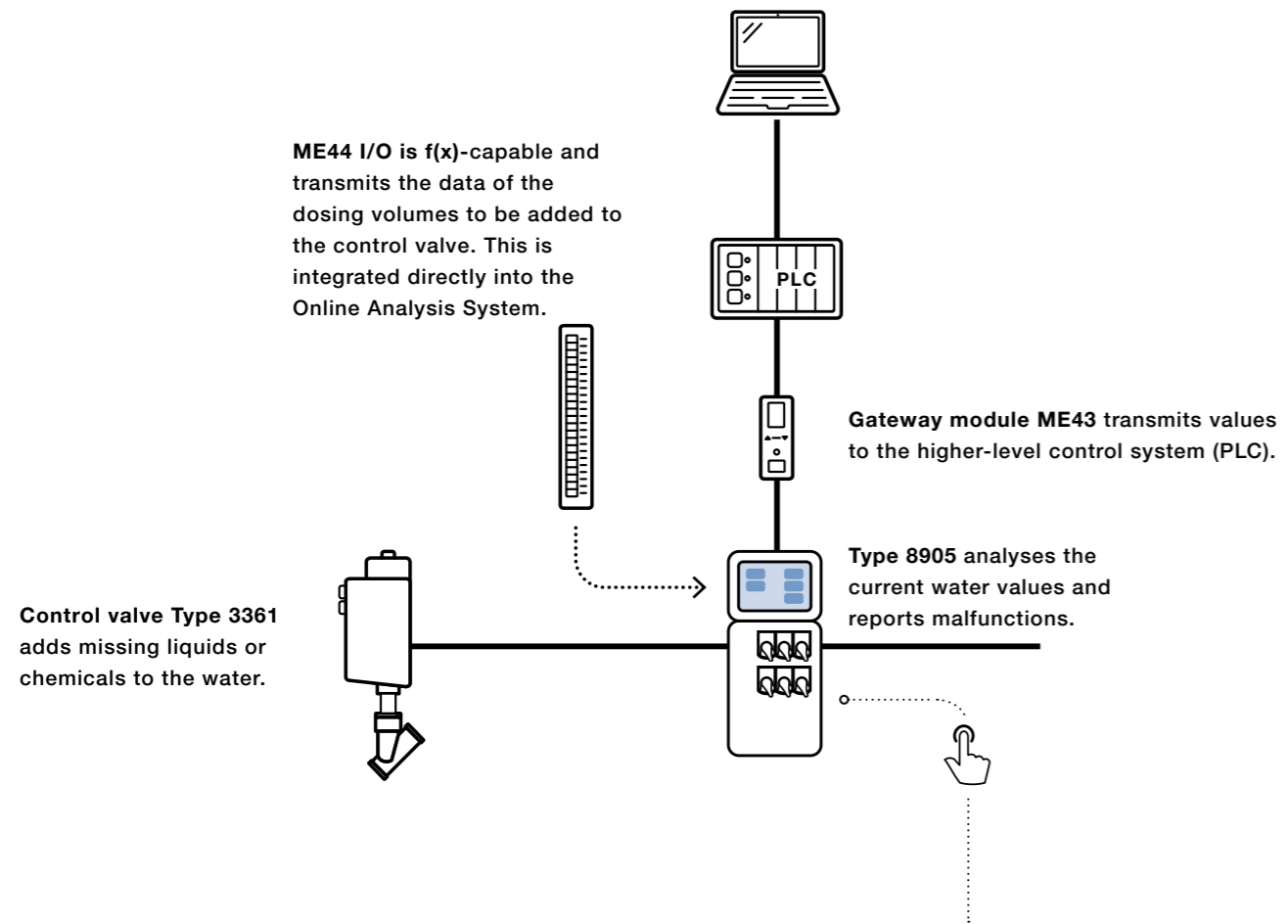

The configuration software "Bürkert Communicator" serves for parameterisation and diagnostic functions of the Online Analysis System. Cyclical values can easily be identified and displayed graphically. The f(x) graphical programming makes it possible to modify processes locally and individually without the need to intervene in the process control system.



Savings potential

Continuous analysis: In conventional plants, samples are taken, analysed and documented manually. While this is achieved automatically and continuously with the help of the Online Analysis System. The consumption of water and sample water as well as the space requirements also differ considerably. When are you going to choose water analysis with added value?

Conventional plant

Plant with Type 8905

Time saving



Sample water consumption

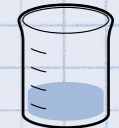

Size savings

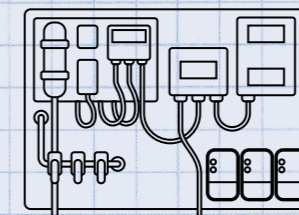

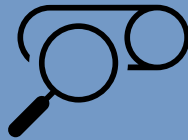

Analysis

Bürkert Fluid Control Systems

Christian-Bürkert-Straße 13–17
74653 Ingelfingen
Germany

Phone: +49 7940 100
Fax: +49 7940 1091204

info@burkert.com
www.burkert.com

burkert